

SAVIE MERCAN



SAVIE MERCAN

Distribuidor exclusivo
da Linha VULCAN e
VICUT no Brasil!

Equipamentos Digitais para
revolucionar a sua gráfica!

 www.saviemercan.com.br



FLATBED CUTTING PLOTTER

FC-500VC / FC-700VC

Perfect for light to medium production and design samples
Ideally suited for packaging boxes, tags, cards and labels

PRODUCT PROFILE

The VICUT Vulcan series flatbed cutter is ideal for small and medium-sized production and samples of packaging, swing tickets, cards and labels. Processing materials include paper, cardboard, synthetics, films and kinds of labels, up to 600gsm.

Using advanced digital contour cutting technology, no cutting dies required, Vulcan series flatbed cutter plotter is able to produce the sheets to any shapes, instantly and directly from the desktop. It can handle full cutting, half cutting, creasing, perforating and plotting.

Two models are available, FC500VC flatbed plotter suits for placing 2pcs SRA3 sheets while FC700VC flatbed cutting plotter allows for 2pcs B2 sheets or one B1 sheet. Users can choose suitable size reasonably according to the size of processing materials, production capacity, floor space, project budget, etc.

APPLICATION

APPLICABLE FIELD

Prototype and light production, DIY paper crafts, tags, on-demand packaging and sheet card cutting system - also suitable for sheet labels.



Plug and play

Electricity can be used, simple installation, no additional drivers needed.



Reverse cutting/creasing

It's necessary for professional users who always like perfect results.



Compatible Os

VICUT Vulcan series flatbed cutting machine can support both Windows and Mac



One-click repeat function

Is great for cutting same jobs, just need to replace paper, press "Back to Origin", then press "Repeat", no skilled people also run it easily.



Multiple cut and crease

For some hard/thick materials, one time cut/crease is not enough, need 2 or 3 times to get nice cutting/creasing results. The cutting and creasing can be separated operation, in practical works.



Continue cutting

If you need to process two or more sheets, when cutting second paper, users can replace first paper, save time for replacing papers.

PROCESS MATERIAL

Cardboard, craft paper, fibrous cardboard, eva rubber, PVC, sandblast, vinyl, sticker, magnetic sticker, PET, TPU, reflective film and thin film etc.

MODEL SELECTOR

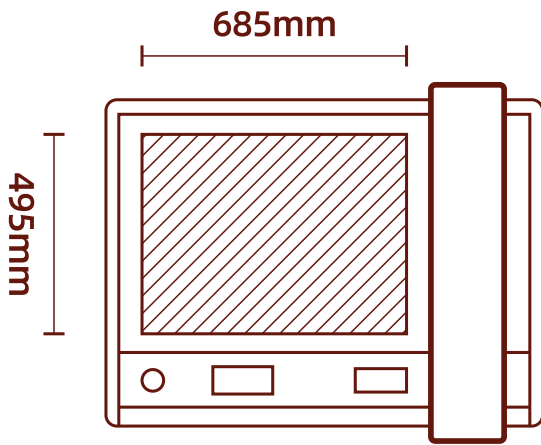

Suitable Paper

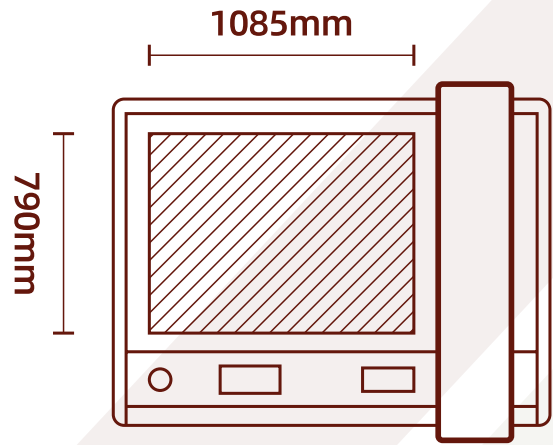

Suitable Paper



Marketing Position

FC-500VC

Effective cutting area 495x685mm. It is suitable for placing 2pcs A3+ sheets or 4pcs A4 sheets next to each other for light production applications, enabling users to achieve higher productivity. Because of its high matching with economical printers on the market, and the competitive price, this model is currently the most popular one.

Marketing Position

FC-700VC

Effective cutting area 790x1085mm. This flatbed plotter is suitable for bigger size sheets production. 4pcs A3+ size paper can be placed on this table next to each other, and it is also suitable for 2pcs B2 sheets or a single sheet of B1 size paper. This model flatbed usually most suitable for post-processing of inkjet and press printing applications.

SAVIE
MERCAN

TECHNICAL PARAMETERS

ITEM	FC-500VC	FC-700VC
Configuration	Digital servo system, Flatbed	
Media hold-down method	Vacuum suction	
Maximum cutting speed	700 mm/s (10 to 700 mm/s)	
Cutting pressure	Tool 1: Max. 5.88N (600gf) Tool 2: Max. 5.88N (600gf)	
Effective cutting area	495x685mm	790x1085mm
Mountable media (Y-axis direction)	640mm	940mm
Minimum character size	5mm square	
Mechanical resolution	0.005mm(5µm)	
Programmable resolution	HP-GL: 0.025mm	
Repeatability	0.1mm	
Standard interfaces	USB2.0(FullSpeed) / U-Disk / Ethernet	
Memory	32MB	
Command sets	HP-GL	
Number of tools	3 tools	
Tool types	Cutter blade/Calibration tool/Creasing tool	
Operating screen	4.3-inch touch LCD	
Powersupply	100 to 240 V AC, 50/60 Hz (Autoswitching)	
Power consumption	Max.150VA(machine), Max.550W(vacuum pump)	
Operating environment	Temperature:10 to 35 degrees C(35 to 95 degrees F)	
Humidity	35 to 75% RH(non-condensing)	
External dimensions	981(Y)x977(X)x1047(H)mm	1420(Y)x1212(X)x1050(H)mm
Packaging dimensions	115x110x61cm (machine) 47x43x37cm (vacuum pump)	525x430x61cm (machine) 47x43x37cm (vacuum pump)
G.W. / N.W.	105kg/77kg (machine) 23/20kg (vacuum pump)	154kg/104kg (machine) 23/20kg (vacuum pump)

SAVIE
MERCAN



DETAILS DESCRIPTION

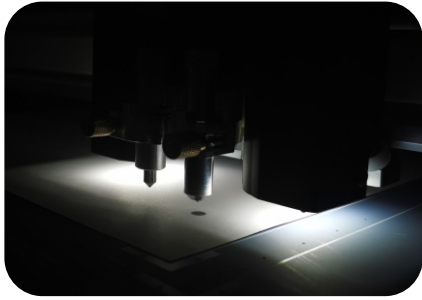

Camera System

The flatbed FC-500VC/FC700VC uses a high-resolution camera to accurately detect registration marks (as small as 5 mm) and reg marks can be seen on both color and transparent materials. The ability to scan small reg marks saves materials and thus reduces production costs. The ability to scan four reg marks saves materials and thus reduces production costs. The ability to scan four reg marks within less than 3 seconds saves production time and reduces costs even further.



User friendly touch screen

Easy toggle of vacuum suction:
ON - fast/stable hold,
OFF - easy replacement of next item;

Easy toggle of arrow key speeds for carriage control: Fast (x10) / Slow (x1);

Single key press to set origin or return to origin - guarantees accurate positioning;
Re-cut button to instantly repeat last job.

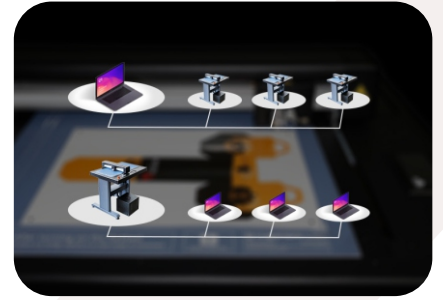

Network interface

A. Stable communications over long distances

B. Control one flatbed cutting plotter from multiple computers

C. Control different flatbed cutting plotters from one computer



U-Disk function

PLT-files saved on USB thumb drives (U-disk) can be used for direct output. This means that the FC-500VC/FC-700VC can be used without being connected to a computer.



QR-code system

The flatbed cutter reads QR-codes on the printed media, allowing automatic matching of print and cut files. This both speeds production and eliminates any chance of mismatched files.



SignCut Pro

Work with SignCut Pro software from Sweden.

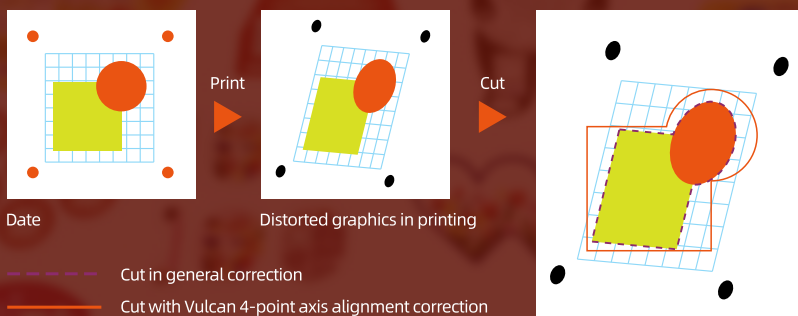

Advanced contour cutting

The VICUT Vulcan flatbed cutter efficiently handles materials loaded on a slant and also compensates for size/shape distortions. Precise and accurate cuts are assured with our proprietary four mark high-tech detection algorithm.

TOOLS & ACCESSORIES



Muffler

Reduce the sound level of vacuum pump, suitable for vacuum pump more than 750W. Mostly used in office which require cutter works quietly.



Vacuum pump

Powerful vacuum pump with acoustic cover, offering enough power to hold the printed sheets on the working table.



Pressure relief valve

Unique design, stabilize air pressure, ensure the steady work of suction system, prolong the service life of vacuum pump.



Grey felt cutting mat

This cutting mat is perfect for achieving deeper creasing lines and cuts. It's also very durable.



Creasing Tool

This tool is double-ended, offering choices of wide or narrow creases. It creases all fold lines with its ball-bearing head, to avoid corrugated damage on media face.



Calibration tool

Used for setting up and calibrate cutter before machine working.



Blade holder

This precision engineered components sits in the dual tool head and holds the cutting blade of choice. The tool is adjustable manually to obtain the desired length of blade-tip.



Cutting Blades

Dedicated cutting blades are specially used for Vulcan series flatbed cutting plotters. The thickest cutting material can reach 2.5mm.

SAVIE
MERCAN

SAMPLE DISPLAY



Hobby crafts



Hobby crafts



Hobby crafts



Labels



Labels



Labels



Packaging



Packaging



Packaging



Tags



Tags



Tags

PACKING PHOTOS



PACKING LIST

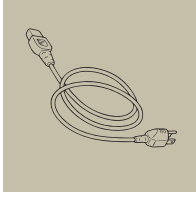

Powercable x 1pc

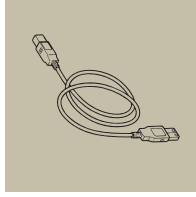

USBCable x 1pc

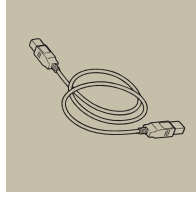

Ethernet cable x 1pc

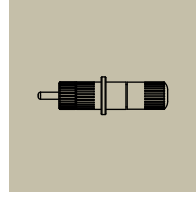

Blade holder x 1pc

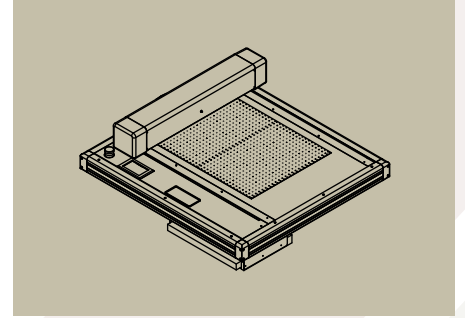
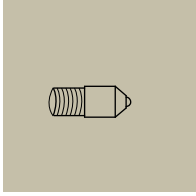
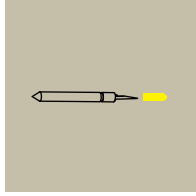

Table X 1pcs



Creasing head x 1pc



30°Blade x 1pc

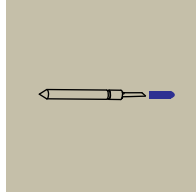

60°Blade x 1pc

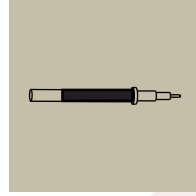

Pen x 5pcs



Creasing mat x1pc

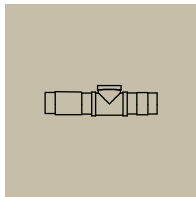

Transfer tube x1set

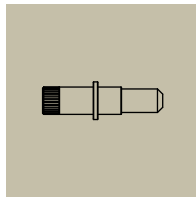

Pen calibration tool x 2pcs

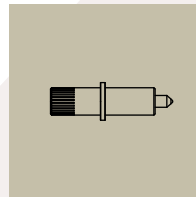

Creasing tool x 1pc

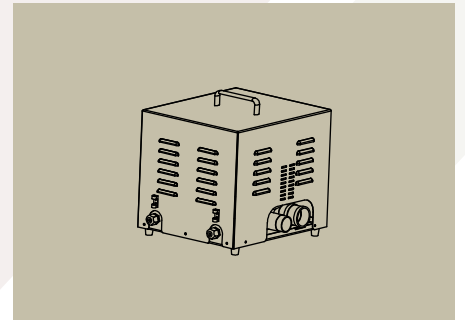

Air Pump X 1pcs

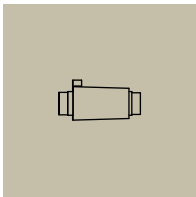

Relief value x 1pc

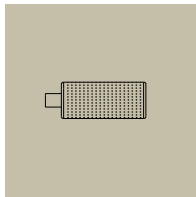

Silencer x1pc

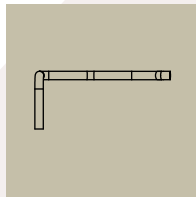

Transfer hose x1pc

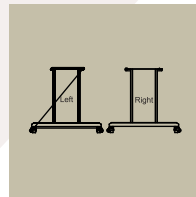

Stand legs x1set

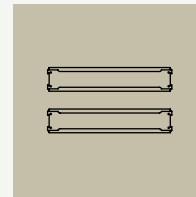

Beams x 2pcs

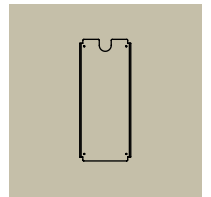

Beam cover x 1pc



SAVIE MERCAN